

2000
commercial

JANUS[®] *[International]*



superior product + recognized value



JANUS[®]

[International]

The model 2000 is the traditional rolling sheet door. Time-honored and established, it is dependable and sturdy. Used in a variety of field applications, it provides an economical alternative to sectional or slat doors. Installation is quick and the cam action device allows for easy adjustment of the springs simultaneously. Backed by a one year warranty, it's a solid investment for commercial door usage.

FEATURES

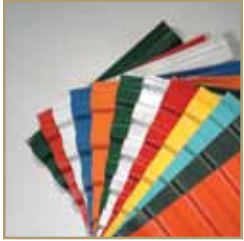

The 26 gauge corrugated door curtain is manufactured from full hard galvanized grade 80 steel and coated with Super Durable polyester paint that is backed by a 40 year film integrity and 25 year no-fade limited paint warranty. Available in sizes up to 12'0" x 18'0" and in over 20 different standard colors.

Tough, durable, wide, heavy duty nylon stripping controls curtain stretch and works in conjunction with the vinyl guide strip to reduce wear and deaden sound.



The slide bolt lock assembly affixed to the bottom bar at each end of the door curtain fastens through the guide to securely keep the door locked and in the down position. Padlocks can be attached to the slide to further secure the door.

The flat door stop slide makes installation quicker. Simply slide through the holder on the guide and affix with a fastener.

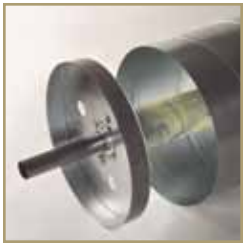

12" diameter drums allow for lower headroom requirements. An enclosed barrel houses the dead axle assembly and protects the factory lubricated springs from direct contact with environmental elements. The inherent strength provided by the spiral barrel minimizes axle deflection providing smoother operation. Because the curtain is attached by screws and not seamed to the barrel, replacement of either independent assembly is cost-effective, quick and easy.

Grease-filled, shielded radial ball bearings at the drums provide longevity and smooth operation. Factory installed insert nuts help make the installation of the chain hoist and operator sprocket easier.



A cam-action spring tension holding device allows quick, easy and equal adjustment of the tension on all springs simultaneously from one end of the door. The cam tensioner bites into the axle helping to eliminate the unwanted spinning of the axle during the initial spring loading or adjustment process.



A reduced drive chain hoist allows for smoother operation on doors over 10'0" wide or 10'0" tall.



superior product + recognized value

Three manufacturing facilities located throughout the United States and a team of experienced door experts are available to assist you with any of your door needs.

2000

commercial

One year warranty on workmanship and material.

Mounting Brackets are engineered and designed with deep embossing for strength, and are independently tested to withstand more than 2,700 pounds per pair. The installation-friendly mounting brackets feature safe rounded edges and slots that allow for easy vertical adjustments as well as various installation preferences.



Convenient spring tension adjustment is accommodated by inserting a common 1/2" ratchet tool into the end of the drive shaft and rotating. Initial loading of the door tension can be easily accomplished with a ratchet without the difficulty of spinning the door. This innovation also allows the tension to be easily measured and managed with a torque wrench.

OPTIONS

Vision panels provide outside visibility and allow light entry through the 5" x 17" panel. Constructed of a translucent polycarbonate panel inside a glossy white 20 gauge frame, the panels create no interference with the operation of the door. The location and number of vision panels are limited by door size. Ask a sales representative for details.



The electrical operation kit includes a sprocket and torque struts that equip the door for wall mounted jackshaft electric operators and can be furnished in lieu of reduced drive chain hoist when provided.

The Pantheon range of low voltage DC operators are designed to fit enclosed internally in the barrel of the rolling door, providing quiet and efficient operation but requiring only minimal side room. The logic controller is designed to be readily compatible with external transmitters, receivers, photo eyes and sensing edges. The operator hand side must be specified when ordering. Ask a sales representative for more details.



Insulation is made of a foil backed, dual layer of heavy-duty polyethylene air-bubble insulation secured in place with a strong adhesive and joined by mylar film to provide an R value of 4. (Top draft stop and side draft stops are also included.)

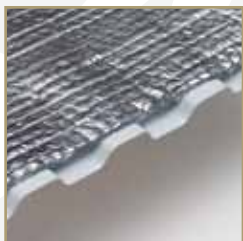

The header seal attaches directly to the header and extends up to 5" to the door curtain to form an effective barrier from environmental elements.

The top draft stop mounted to the door curtain provides a 2-1/4" weather seal between the door and the header.

GUIDE DETAILS

Universal mount 2 1/2" deep 16 gauge galvanized steel guides require no pre-installation modifications for wood, steel, concrete or masonry block applications.

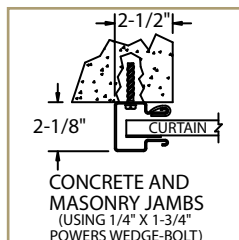
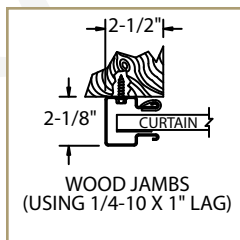
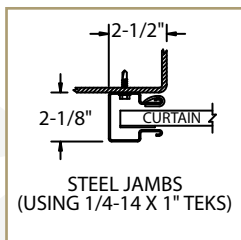

Side Room Requirements

Operation	Guide	Outside of Bracket Tensioner End	Outside of Hand Chain Drive	Outside of Bracket Drive End	Each End of Axle
Push Up	2- 1/2"	4- 1/8"	N/A	4- 1/8"	7"
Reduced Drive Chain	2- 1/2"	4- 1/8"	6- 3/8"	4- 7/8"	7"
Electric	2- 1/2"	4- 1/8"	N/A	5- 5/8"	7"

IMPORTANT NOTES

- Dimensions are referenced from edge of opening.
- Tensioner end and drive end can be installed at either end of door assembly.
- FOR CRITICAL FITS DUE TO REDUCED AVAILABLE HEADROOM or SIDEROOM CLEARANCES, CONSULT FACTORY.

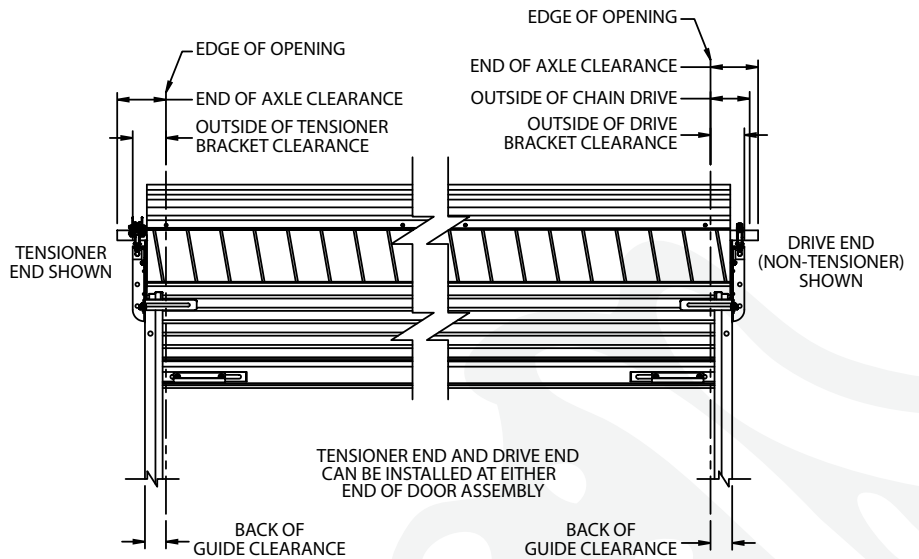
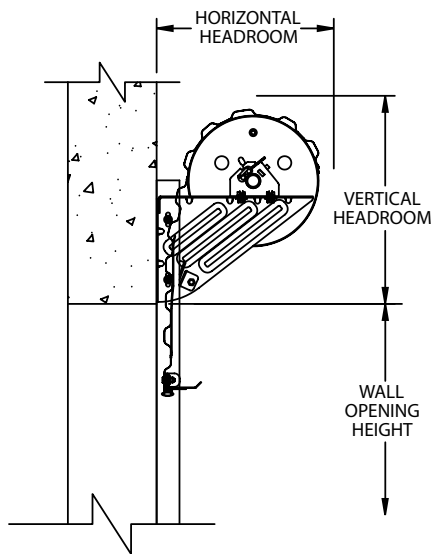

JANUS INTERNATIONAL

{ headquarters }
p.o. box 567
temple, georgia 30179

{ manufacturing facilities }
134 janus international blvd.
temple, georgia 30179
+
1256 brittmore road
houston, texas 77043
+
13374 west peoria avenue
surprise, arizona 85379

{ distribution centers }
2535 west la palma avenue
anaheim, california 92801
+
10407 rocket blvd
orlando, florida 32824

Head Room Requirements

Opening Height	Vertical Headroom	Horizontal Headroom
Thru 8'0"	20"	20"
Over 8'0" thru 10'0"	21"	21"
Over 10'0" thru 14'0"	21 1/2"	21"
Over 14'0" thru 16'0"	22"	21"
Over 16'0" thru 18'0"	22"	22"
Over 18'-0" thru 20'-0"	22"	22"

PH **1 866 562 2580**
FX **1 770 562 0328**
www.janusintl.com

proud members of:

